

Swagelok® Hydrogen- Compatible Products

for the Hydrogen Mobility
Industry

Products that are compatible for
use in hydrogen on-vehicle and
infrastructure applications, available
from your local authorized sales and
service center.

The design and operation of
hydrogen systems are the
responsibility of the user, who should
obtain qualified assistance to ensure
their safe use of hydrogen.

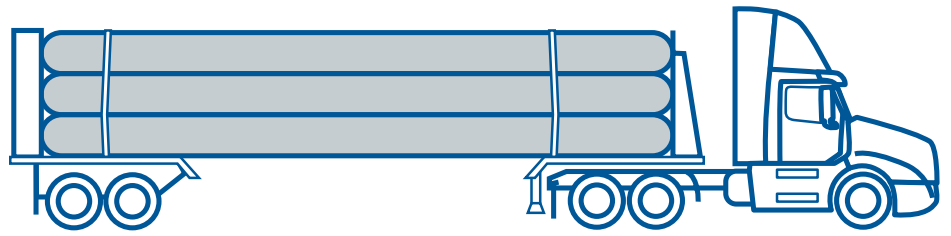

Gaseous Tube Trailer

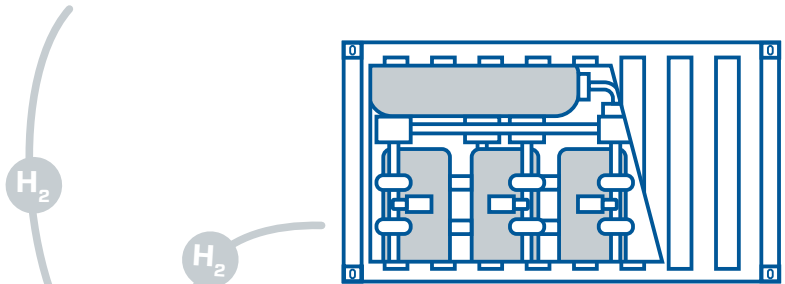

Electrolyzer System

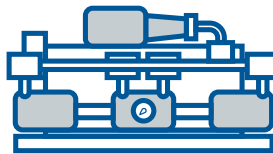

Compressor

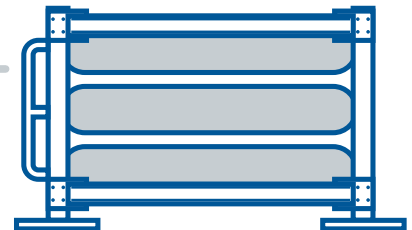

**Compressed Hydrogen
Storage Tanks**

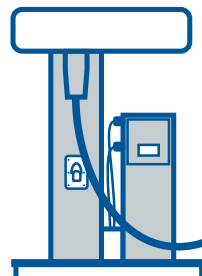

Dispenser

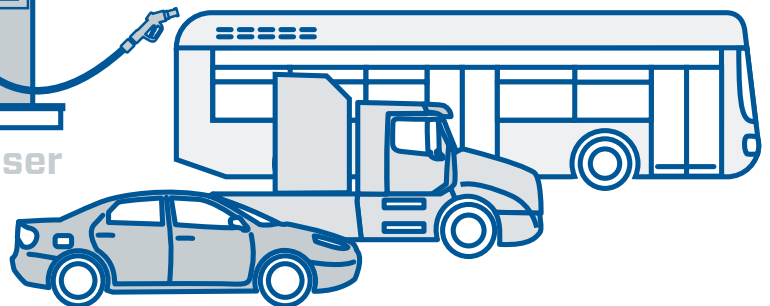

Fuel Cell Electric Vehicles

Swagelok®

Introduction

Hydrogen fuel cell technology requires high-integrity fluid system components to fill and store hydrogen in cylinders and transfer it to the fuel cell on the vehicle. Swagelok offers a wide range of fluid system components for use in many types of hydrogen-related applications including the infrastructure that produces, transports, compresses, stores, and fills cylinders with hydrogen and for on-vehicle use.

Swagelok products, as listed in this document, are compatible with both on-vehicle and infrastructure hydrogen applications. Hydrogen-compatible products have had the materials of construction reviewed for appropriate use with hydrogen. Some metals are susceptible to hydrogen embrittlement, specifically hardened Belleville springs and stems. These have been replaced with less susceptible materials for compatibility with hydrogen service. Some elastomers are also more susceptible to hydrogen degradation and have been replaced with more resilient materials. Products not listed in this document may not be suitable for hydrogen applications.

Contents

Introduction	2
Infrastructure Applications	3
Hydrogen-Compatible Products for Applications Up to 1 378 bar (20 000 psig)	4
On-Vehicle Applications	6
H35 Pressure Class	
Fittings With EC-79 Certification for Systems Above 30 bar (435 psig) and Up to 350 bar (5 076 psig)	7
Valves With EC-79 Certification for Systems Above 30 bar (435 psig) and Up to 350 bar (5 076 psig)	9
Ordering Numbers and Dimensions for Fittings and Valves With EC-79 Certification for Systems Above 30 bar (435 psig) and Up to 350 bar (5 076 psig)	
Fittings	
Assembly-by-Torque (AbT)	10
Tube	11
Pipe	17
Valves	
Alternative Fuel Service Ball Valves (AFS Series)	19
Check Valves	20
Industrial Excess Flow Valves	21
Filters	22
H70 Pressure Class	
Fittings With EC-79 Certification for Systems Above 30 bar (435 psig) and Up to 700 bar (10 159 psig)	24
Ordering Numbers and Dimensions for Fittings With EC-79 Certification for Systems Above 30 bar (435 psig) and Up to 700 bar (10 159 psig)	
Fittings	
Assembly-by-Torque (AbT)	26
FK Series	27
Tube	32
Pipe	35
Replacement Parts	36

Infrastructure Applications

Infrastructure applications include the dispensers, storage cylinders, compressors, separators, and pressure control devices that make up the station, as well as the hydrogen tube trailers that bring the hydrogen to the stations. Components in these locations must be hydrogen-compatible but may not require specific certifications. In addition to standard Swagelok tube fittings, a range of FK series medium-pressure fittings, cone and thread fittings, hoses, valves, and pressure gauges that are hydrogen-compatible are available.

Note: For these applications, regional standards and specifications may vary. Please consult your local authorized Swagelok sales and service center for more information.



Gaseous Tube Trailer

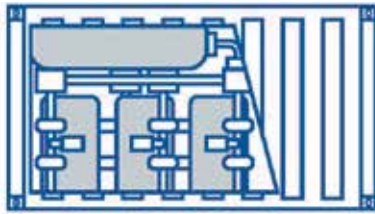

Electrolyzer System

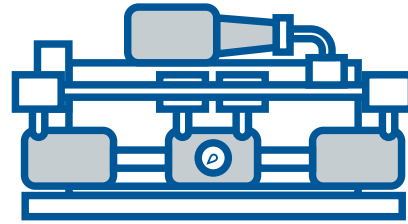

Compressor

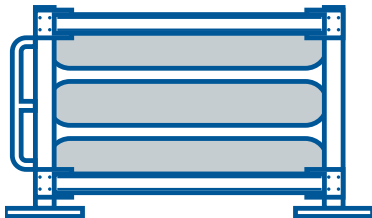

Compressed Hydrogen Storage Tanks

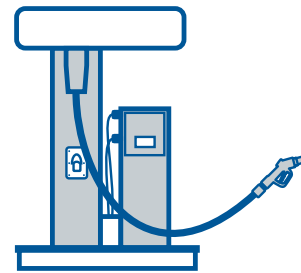

Dispenser

The following provides a list of products that are hydrogen-compatible for use in infrastructure applications. Refer to Hydrogen-Compatible Products for Applications Up to 1 378 bar (20 000 psig) on page 4 for additional information.

- Swagelok tube fittings and tubing
- FK series medium-pressure fittings and tubing
- FKB series medium-pressure ball valves
- IPT check valves
- IPT series cone and thread fittings and tubing
- AFS series ball valves
- FJ, FL, FM, and FX series hose
- S model pressure gauges
- Pipe fittings
- Swagelok Custom Solutions, such as filling, distribution, priority, and control panels and tubing manifolds.

Hydrogen-Compatible Products for Applications Up to 1 378 bar (20 000 psig)

These products may be ordered using standard ordering numbers given in the product literature, except where noted. Individual product ratings are as noted in the product literature.

Product	Product Type/ Series	Description	Available Sizes	Working Pressure and Ordering Information
Fitting	Tube	Straight, elbow, tee, and cross standard tube fitting	1/16 to 2 in. 2 to 50 mm	Refer to Tubing Data, MS-01-107, for pressure rating information. Refer to Gaugeable Tube Fittings and Adapter Fittings, MS-01-140, for ordering information.
		Assembly-by-Torque (AbT)	1/4 to 1/2 in. 6 to 12 mm	Refer to Assembly-by-Torque (AbT) Fittings, MS-02-466, for additional information
		Medium-pressure, FK series	1/4 to 1 in. 6 to 12 mm	Refer to Medium- and High-Pressure Fittings, Tubing, Valves, and Accessories catalog, MS-02-472, for additional information.
	Cone and Thread, IPT	Medium- and high-pressure cone and thread, medium-pressure pipe fittings and adapters	1/4 to 1 1/2 in.	Refer to Medium- and High-Pressure Fittings, Tubing, Valves, and Accessories catalog, MS-02-472, for additional information.
	Pipe	NPT/ISO	1/16 to 1 1/2 in.	Refer to Pipe Fittings catalog, MS-01-147, and Medium- and High-Pressure Fittings, Tubing, Valves, and Accessories, MS-02-472, for additional information.
		Male/female SAE	3/16 to 1 in.	Refer to Pipe Fittings catalog, MS-01-147, for additional information
	VCO with ethylene propylene O-rings only	O-ring face seal	1/8 to 1 in.	Refer to VCO O-ring Face Seal Fittings, MS-01-28, add -EP to selected ordering number
	VCR with 316 stainless steel gaskets only	Metal gasket face seal	1/8 to 1 in.	Refer to VCR Metal Gasket Face Seal Fittings, MS-01-24, 316 stainless steel gaskets only
Hose	FJ	304 SS single braid layer reinforcement, 316L stainless steel annular convoluted core	1/4 to 2 in.	Refer to Hose and Flexible Tubing catalog, MS-01-180, for ordering information.
	FL	321 stainless steel single braid layer reinforced, 316L stainless steel annular convoluted core	1/4, 1/2 in.	
	FM	316L stainless steel single braid layer reinforced, 316L stainless steel annular convoluted core	1/4 to 2 in.	
	FX	321 stainless steel double braid layer reinforced, 316L stainless steel annular convoluted core	1/4 to 2 in.	

Please consult your local authorized Swagelok sales and service center with any questions.

Products not listed in this document may not be suitable for hydrogen applications.

Hydrogen-Compatible Products for Applications Up to 1 378 bar (20 000 psig), continued

These products may be ordered using standard ordering numbers given in the product literature, except where noted. Individual product ratings are as noted in the product literature.

Product	Product Type/Series	Description	Working Pressure and Ordering Information
Tubing	316/316L seamless instrumentation grade	Stainless steel seamless tubing, ASTM A213/A269 1/8 to 2 in. and 3 to 25 mm	Refer to Stainless Steel Seamless Tubing and Tube Support Systems catalog, MS-01-181, for additional information.
	Medium-pressure	Stainless steel medium-pressure tubing, ASTM A213/A269 1/4, 3/8, 1/2, and 3/4 in.	Refer to Medium- and High-Pressure Fittings, Tubing, Valves, and Accessories catalog, MS-02-472, for additional information.
	Cone and thread	Stainless steel cone and thread tubing, medium-pressure ASTM A213 1/4 to 1 in.	Refer to Medium- and High-Pressure Fittings, Tubing, Valves, and Accessories catalog, MS-02-472, for additional information.
Valve	AFS	Alternative fuel service (AFS) ball valve, 1/4-turn, PEEK seats	Refer to Swagelok Alternative Fuel Service (AFS) Ball Valves catalog, MS-02-303, for additional information.
	FKB	Medium-pressure trunion-style ball valve, PEEK seat	1 034 bar at -40°C to 85°C (15 000 psig at -40°F to 185°F) SS-6FKBFK6-53402 SS-8FKBFK8-53402 SS-12FKBFK12-53402 Refer to Medium- and High-Pressure Fittings, Tubing, Valves, and Accessories catalog, MS-02-472, for additional information.
	SK	Multipurpose ball valve, 1/4-turn, PEEK seats	Refer to Multipurpose Ball Valves catalog, MS-02-345, for additional information.
Gauge	PGI	S and B model industrial pressure gauge	Refer to Process Gauges, Industrial and Process catalog, MS-02-170, for additional information.

Please consult your local authorized Swagelok sales and service center with any questions.

Products not listed in this document may not be suitable for hydrogen applications.

On-Vehicle Applications

On-vehicle applications include light-duty (car and van), heavy-duty (bus and truck), rail, ship, and aerospace. Components used in light-duty cars and vans and heavy-duty trucks and buses may require EC-79 certification for use at working pressures above 30 bar (435 psig). Specific testing is required to achieve this certification, including corrosion resistance, endurance, hydraulic pressure cycle testing, and external leakage testing. Products with this certification are specially marked to reflect the approval. Products are certified to EC-79 based on the nominal pressure of either H35 or H70 pressure classes. All products are tested and certified to the MAWP for the pressure class.

Fuel Cell Electric Vehicles

Hydrogen-compatible Products Available

Refer to Hydrogen-Compatible Products for Applications Up to 1 378 bar (20 000 psig) on page 4 for additional information.

- Assembly-by-torque (AbT) fittings
- Swagelok tube fittings
- FK series medium-pressure fittings
- CH series check valves
- Alternative fuel service ball valves
- XS series industrial excess flow valves
- TF and FW series filters
- Pressure gauges
- All-metal hose
- Swagelok tubing
- Swagelok® Custom Solutions, such as CNC bent fuel lines

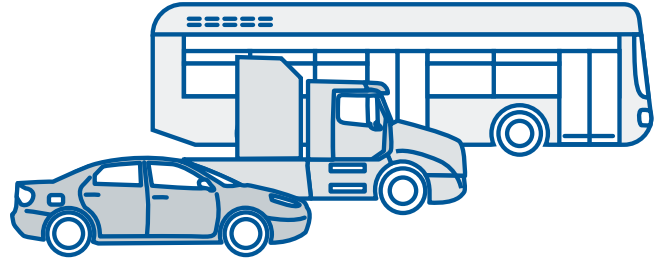

EC-79 Certified Products:

EC-79 certification for on vehicle applications come in two pressure classes:

- H35 pressure class is for nominal working pressure from 30 bar (435 psig) to 350 bar (5 076 psig) see page 7 and 9 for additional information.
- H70 pressure class is for nominal working pressure from 30 bar (435 psig) to 700 bar (10 159 psig) see page 24 and 25 for additional information

Fittings With EC-79 Certification for Systems Above 30 bar (435 psig) and Up to 350 bar (5 076 psig), Temperature -40 to 120°C (-40 to 248°F) – H35 Pressure Class

Product	Product Type	Description	Available Sizes ^①
Tube fitting	AbT	AbT Nut and Ferrule Set	Tube fitting sizes: 1/4, 3/8, 1/2 in. 6, 8, 10, 12 mm Ordering Information: pages 10
	Straight	Union - Swagelok tube fitting to Swagelok tube fitting Port connector Cap Plug	Tube fitting sizes: 1/4, 3/8, 1/2, 5/8 in. 6, 8, 10, 12, 16 mm Ordering Information: pages 11 and 14
		Male connector - Swagelok tube fitting to 1/4 in. male NPT	Tube fitting sizes: 1/4, 3/8, 1/2, 5/8 in. 6, 8, 10, 12 mm Ordering Information: page 11
		Male connector - Swagelok tube fitting to SAE/MS straight thread (ST and STH) fitting ^②	Tube fitting sizes: 1/4, 3/8, 1/2, 5/8 in. 6, 8, 10, 12 mm SAE/MS straight thread Male: ST: 7/16-20, 9/16-18, STH: 3/4-16 Ordering Information: page 12
		Female connector - Swagelok tube fitting to 1/4 in. female NPT	Tube fitting sizes: 1/4, 5/16, 3/8, 1/2 in. 6, 8, 10, 12 mm Ordering Information: page 12
		Reducer - Swagelok tube fitting to tube adapter	1/4, 3/8, 1/2 in. 6, 8, 10, 12 mm Ordering Information: page 13
	Elbow	Union - Swagelok tube fitting to Swagelok tube fitting	1/4, 3/8, 1/2, 5/8 in. 6, 8, 10, 12, 16 mm Ordering Information: page 15
	Tee	Union - all Swagelok tube fitting ends	1/4, 3/8, 1/2, 5/8 in. 6, 8, 10, 12, 16 mm Ordering Information: page 15
	Cross	Union - all Swagelok tube fitting ends	1/4, 3/8, 1/2 in. 6, 8, 10, 12, 16 mm Ordering Information: page 15

① Additional sizes are available. Contact your local authorized Swagelok sales and service center for details.

② O-ring material is 75 durometer fluorocarbon FKM.

Fittings With EC-79 Certification for Systems Above 30 bar (435 psig) and Up to 350 bar (5 076 psig), Temperature -40 to 120°C (-40 to 248°F) — H35 Pressure Class, continued

Product	Product Type	Description	Available Sizes ^①
Tube adapter	Male	1/4 in. NPT	Tube adapter sizes: 1/4, 3/8, 1/2 in. 6, 8, 10, 12 mm Ordering Information: page 16
		SAE/MS straight thread (ST and STH) ^②	Tube adapter sizes: 1/4, 3/8, 1/2 in. 6, 8, 10, 12 mm SAE/MS straight thread ST: 7/16-20, 9/16-18 STH: 3/4-16 Ordering Information: page 16
	Female	1/4 in. NPT	Tube adapter sizes: 1/4, 3/8, 1/2 in. 6, 8, 10, 12 mm Ordering Information: page 16
Pipe fitting	Adapter	Male SAE/MS straight thread to 1/4 in. male NPT ^②	SAE/MS straight thread 7/16-20 to 1/4 in. NPT Ordering Information: page 17
		Male SAE/MS straight thread to 1/4 in. female NPT ^②	SAE/MS straight thread 7/16-20 to 1/4 in. NPT Ordering Information: page 17
	Reducer	Male to female SAE/MS straight thread (ST) ^②	SAE/MS straight thread ST: 9/16-18 to 7/16-20 STH: 3/4-16 Ordering Information: page 17
	Plug	1/4 in. Male NPT	1/4 in. Ordering Information: page 17
	Hollow hex plug	Male SAE/MS straight thread (ST and STH) ^②	SAE/MS straight thread ST: 3/8-24, 7/16-20, 9/16-18, STH: 3/4-16 Ordering Information: page 18
	Hex head plug	Male SAE/MS straight thread (ST and STH) ^②	SAE/MS straight thread ST: 3/8-24, 7/16-20, 9/16-18 STH: 3/4-16 Ordering Information: page 18
	Pipe cap	Female NPT	1/4 in. Ordering Information: page 18

^① Additional sizes are available. Contact your local authorized Swagelok sales and service center for details.

^② O-ring material is 75 durometer fluorocarbon FKM.

Valves With EC-79 Certification for Systems Above 30 bar (435 psig) and Up to 350 bar (5 076 psig), – H35 Pressure Class

Product	Series	Temperature	Description	Available Sizes
Valves	AFS	-40 to 120°C (-40 to 248°F)	Alternative fuel service (AFS) ball valve, 1/4-turn, PEEK seats	Fractional Swagelok tube fitting: 3/8, 1/2 in. Metric Swagelok tube fitting: 12, 16 mm Female NPT: 3/8, 1/2 in. SAE/MS straight thread ST: 3/4-16 Additional Information on page 19
	Check CH Series	-40 to 85°C (-40 to 185°F)	Poppet check valve Seal materials: Ethylene propylene or neoprene	Fractional Swagelok tube fitting: 1/4, 3/8, 1/2 in. Metric Swagelok tube fitting: 6, 8, 10, 12 mm Female NPT: 1/4 in. Male NPT: 1/4, 3/8, 1/2 in. Additional Information on page 20
	Industrial Excess XS Series		Industrial excess flow valves Seal materials: Ethylene propylene	Fractional Swagelok tube fitting: 1/4 in. Metric Swagelok tube fitting: 6 mm Female NPT: 1/4 in. Additional Information on page 21
Filters	TF Series		Tee-type filters Nominal pore size: 0.5, 2, 7, 15 µm	Swagelok tube fitting: 1/4, 3/8, 1/2 in., 6, 8, 10, 12 mm Female NPT: 1/8 in. Male NPT: 1/4 in. Additional Information on page 22
	FW Series		All-welded inline filters Nominal pore size: 0.5, 2, 7, 15 µm	Swagelok tube fitting: 1/4 in., 6 mm Female NPT: 1/4 in. Male NPT: 1/4 in. Additional Information on page 23

Ordering Numbers and Dimensions for Fittings With EC-79 Certification for Systems Above 30 bar (435 psig) and Up to 350 bar (5 076 psig), Temperature -40 to 120°C (-40 to 248°F) – H35 Pressure Class

Assembly-by-Torque (AbT) Fittings

AbT Nut and Ferrule Set (sold separately for easy installation)

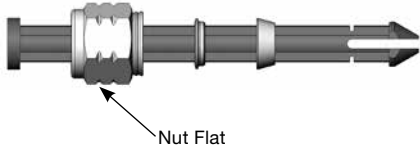

Marking

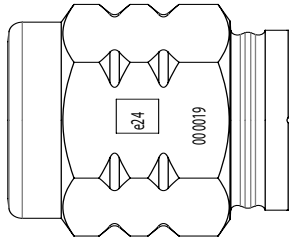

Tube OD	Ordering Number ^①	Sets per Blister Pack	Dimension
			Nut Flat
Fractional, in.			
1/4	SS-4ABT-NFSET-HV35	50	9/16 in.
3/8	SS-6ABT-NFSET-HV35	50	11/16 in.
1/2	SS-8ABT-NFSET-HV35	50	7/8 in.
Metric, mm			
6	SS-6MABT-NFSET-HV35	50	14 mm
8	SS-8MABT-NFSET-HV35	50	5/8 in.
10	SS-10MABT-NFSET-HV35	50	3/4 in.
12	SS-12MABT-NFSET-HV35	50	22 mm

^① Order in blister packs.

AbT Body Only Ordering Information:

- AbT union body see page 11 for base ordering number and dimensions, add **BO** to base ordering number.
Example: SS-400-6**BO**-HV35
- AbT male connector body SAE/MS straight thread (ST) see page 12 for base ordering number and dimensions, add **BO** to base ordering number.
Example: SS-400-1-4STDE**BO**-HV35
- AbT elbow union body see page 15 for base ordering number and dimensions, add **BO** to base ordering number.
Example: SS-400-9**BO**-HV35
- AbT tee union body see page 15 for base ordering number and dimensions, add **BO** to base ordering number.
Example: SS-400-3**BO**-HV35
- AbT cross union see page 15 for base ordering number and dimensions, add **BO** to base ordering number.
Example: SS-400-4**BO**-HV35

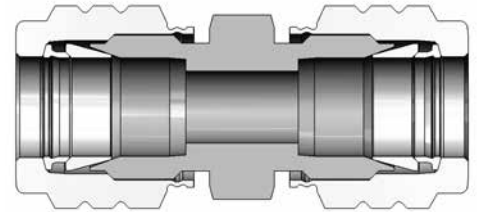

Refer to *Assembly-by-Torque (AbT) Fittings* catalog, MS-02-466, for additional information.

Straight Tube Fittings

Marking

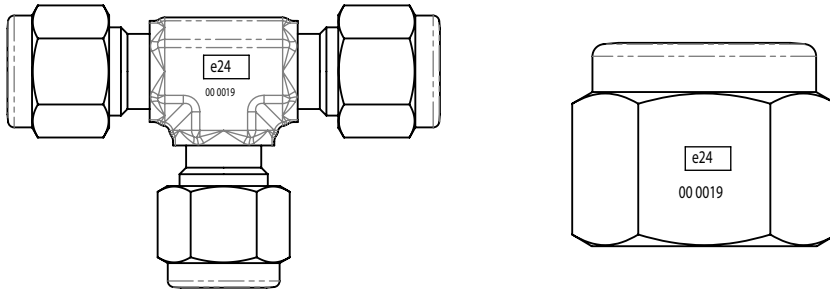

Unions

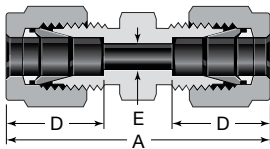

Tube OD	Ordering Number	Dimensions		
		A	D	E
Dimensions, in.				
1/4	SS-400-6-HV35	1.61	0.60	0.19
3/8	SS-600-6-HV35	1.77	0.66	0.28
1/2	SS-810-6-HV35	2.02	0.90	0.41
5/8	SS-1010-6-HV35	2.05	0.96	0.50
Dimensions, mm				
6	SS-6M0-6-HV35	41.0	15.3	4.8
8	SS-8M0-6-HV35	43.2	16.2	6.4
10	SS-10M0-6-HV35	46.2	17.2	7.9
12	SS-12M0-6-HV35	51.2	22.8	9.5
16	SS-16M0-6-HV35	52.0	24.4	12.7

Male Connectors

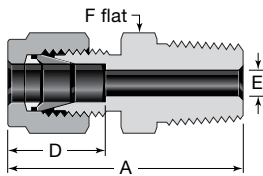

NPT

Tube OD	NPT Size	Ordering Number	Dimensions			
			A	D	E ^①	F
Dimensions, in.						
1/4	1/4	SS-400-1-4-HV35	1.49	0.60	0.19	9/16
3/8		SS-600-1-4-HV35	1.57	0.66	0.28	5/8
1/2		SS-810-1-4-HV35	1.71	0.90	0.28	13/16
5/8		SS-1010-1-4-HV35	1.74	0.96	0.28	15/16
Dimensions, mm						
6	1/4	SS-6M0-1-4-HV35	37.9	15.3	4.8	14
8		SS-8M0-1-4-HV35	38.7	16.2	6.4	15
10		SS-10M0-1-4-HV35	40.9	17.2	7.1	18
12		SS-12M0-1-4-HV35	43.4	22.8	7.1	22

① The E dimension is the minimum nominal opening. These fittings may have a larger opening at the pipe/straight thread end.

Additional sizes are available. Contact your local authorized Swagelok sales and service center for details.

Straight Tube Fittings

Male Connectors

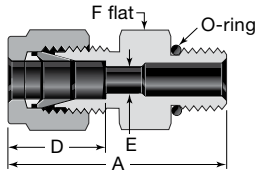

Adapts to SAE J1926/1 and ISO 11926-1 straight thread boss.

SAE/MS Straight Thread (ST) and (STH - heavy wall)

Tube OD	SAE/MS Thread Size	Ordering Number	Dimensions			
			A	D	E ^②	F
Dimensions, in.						
1/4	7/16-20	SS-400-1-4ST-HV35	1.34	0.60	0.19	9/16
	9/16-18	SS-400-1-6ST-HV35	1.40			11/16
	3/4-16	SS-400-1-8STH-HV35	1.57			7/8
3/8	7/16-20	SS-600-1-4ST-HV35	1.40	0.66	0.20	5/8
	9/16-18	SS-600-1-6ST-HV35	1.46			11/16
	3/4-16	SS-600-1-8STH-HV35	1.63			7/8
1/2	9/16-18	SS-810-1-6ST-HV35	1.54	0.90	0.28	13/16
	3/4-16	SS-810-1-8STH-HV35	1.74			7/8
5/8	3/4-16	SS-1010-1-8STH-HV35	1.74	0.96	0.39	15/16
Dimensions, mm						
6	7/16-20	SS-6M0-1-4ST-HV35	34.0	15.3	4.8	14
	9/16-18	SS-6M0-1-6ST-HV35	35.6			18
8	7/16-20	SS-8M0-1-4ST-HV35	35.0	16.2	5.2	15
	9/16-18	SS-8M0-1-6ST-HV35	36.6			18
10	7/16-20	SS-10M0-1-4ST-HV35	35.8	17.2	5.2	18
	9/16-18	SS-10M0-1-6ST-HV35	37.3			18
	3/4-16	SS-10M0-1-8STH-HV35	39.4			22
12	7/16-20	SS-12M0-1-4ST-HV35	40.6	22.8	5.2	22
	9/16-18	SS-12M0-1-6ST-HV35	39.9			
	3/4-16	SS-12M0-1-8STH-HV35	41.9			

① O-ring material is 75 durometer fluorocarbon FKM.

② The E dimension is the minimum nominal opening. These fittings may have a larger opening at the pipe/straight thread end.

Female Connectors

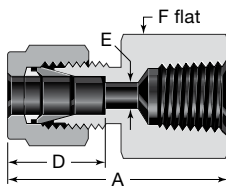

NPT

Tube OD	NPT Size	Ordering Number	Dimensions			
			A	D	E	F
Dimensions, in.						
1/4	1/4	SS-400-7-4-HV35	1.41	0.60	0.19	3/4
5/16	1/4	SS-500-7-4-HV35	1.45	0.64	0.25	3/4
3/8	1/4	SS-600-7-4-HV35	1.48	0.66	0.28	3/4
1/2	1/4	SS-810-7-4-HV35	1.59	0.90	0.41	13/16
Dimensions, mm						
6	1/4	SS-6M0-7-4-HV35	35.8	15.3	4.8	19
8	1/4	SS-8M0-7-4-HV35	37.0	16.2	6.4	19
10	1/4	SS-10M0-7-4-HV35	37.8	17.2	7.9	19
12	1/4	SS-12M0-7-4-HV35	40.3	22.8	9.5	22

Additional sizes are available. Contact your local authorized Swagelok sales and service center for details.

Straight Tube Fittings

Reducers

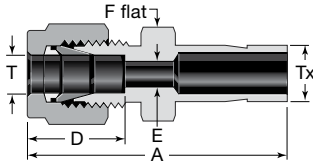

Tube OD		Ordering Number	Dimensions			
T	Tx		A	D	E	F
Dimensions, in.						
1/4	1/4	SS-400-R-4-HV35	1.54	0.60	0.17	1/2
	3/8	SS-400-R-6-HV35	1.60		0.19	1/2
	1/2	SS-400-R-8-HV35	1.82		0.19	9/16
3/8	1/4	SS-600-R-4-HV35	1.63	0.66	0.17	5/8
	3/8	SS-600-R-6-HV35	1.70		0.27	5/8
	1/2	SS-600-R-8-HV35	1.91		0.28	5/8
	5/8	SS-600-R-10-HV35	1.98		0.28	11/16
1/2	1/4	SS-810-R-4-HV35	1.77	0.90	0.17	13/16
	3/8	SS-810-R-6-HV35	1.84		0.27	
	1/2	SS-810-R-8-HV35	2.06		0.37	
	5/8	SS-810-R-10-HV35	2.12		0.41	
Dimensions, mm						
6	8	SS-6M0-R-8M-HV35	39.9	15.3	4.8	14
	10	SS-6M0-R-10M-HV35	40.7			
	12	SS-6M0-R-12M-HV35	46.3			
8	6	SS-8M0-R-6M-HV35	40.3	16.2	4.1	15
	10	SS-8M0-R-10M-HV35	42.0		6.4	
	12	SS-8M0-R-12M-HV35	47.6		6.4	
10	6	SS-10M0-R-6M-HV35	42.4	17.2	4.1	18
	8	SS-10M0-R-8M-HV35	43.4		5.6	
	12	SS-10M0-R-12M-HV35	49.8		7.9	
	15	SS-10M0-R-15M-HV35	51.3		7.9	
12	6	SS-12M0-R-6M-HV35	44.9	22.8	4.1	22
	8	SS-12M0-R-8M-HV35	45.9		5.6	
	10	SS-12M0-R-10M-HV35	46.7		7.1	
	16	SS-12M0-R-16M-HV35	53.8		9.5	

Additional sizes are available. Contact your local authorized Swagelok sales and service center for details.

Straight Tube Fittings

Port Connectors

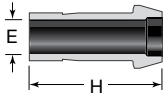

Tube OD	Ordering Number	Dimensions	
		E	H
Dimensions, in.			
1/4	SS-401-PC-HV35	0.17	0.98
3/8	SS-601-PC-HV35	0.27	1.05
1/2	SS-811-PC-HV35	0.37	1.43
5/8	SS-1011-PC-HV35	0.47	1.49
Dimensions, mm			
6	SS-6M1-PC-HV35	4.1	25.0
8	SS-8M1-PC-HV35	5.6	26.0
10	SS-10M1-PC-HV35	7.1	27.1
12	SS-12M1-PC-HV35	8.8	36.2
16	SS-16M1-PC-HV35	12.0	37.8

Caps and Plugs

Cap

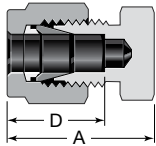

Tube OD	Ordering Number	A	D
Dimensions, in.			
1/4	SS-400-C-HV35	0.92	0.60
3/8	SS-600-C-HV35	1.01	0.66
1/2	SS-810-C-HV35	1.21	0.90
5/8	SS-1010-C-HV35	1.24	0.96
Dimensions, mm			
6	SS-6M0-C-HV35	23.1	15.3
8	SS-8M0-C-HV35	24.5	16.2
10	SS-10M0-C-HV35	26.6	17.2
12	SS-12M0-C-HV35	30.6	22.8
16	SS-16M0-C-HV35	31.4	24.4

Plug

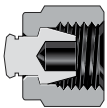

Tube OD	Ordering Number
Dimensions, in.	
1/4	SS-400-P-HV35
3/8	SS-600-P-HV35
1/2	SS-810-P-HV35
5/8	SS-1010-P-HV35
Dimensions, mm	
6	SS-6M0-P-HV35
8	SS-8M0-P-HV35
10	SS-10M0-P-HV35
12	SS-12M0-P-HV35
16	SS-16M0-P-HV35

Additional sizes are available. Contact your local authorized Swagelok sales and service center for details.

90° Elbows

Unions

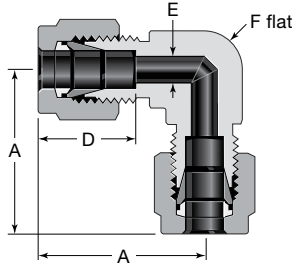

Tube ports are identical.

Tube OD	Ordering Number	Dimensions			
		A	D	E	F, in.
Dimensions, in.					
1/4	SS-400-9-HV35	1.06	0.60	0.19	1/2
3/8	SS-600-9-HV35	1.20	0.66	0.28	5/8
1/2	SS-810-9-HV35	1.42	0.90	0.41	13/16
5/8	SS-1010-9-HV35	1.50	0.96	0.50	15/16
Dimensions, mm					
6	SS-6M0-9-HV35	27.0	15.3	4.8	1/2
8	SS-8M0-9-HV35	28.8	16.2	6.4	9/16
10	SS-10M0-9-HV35	31.5	17.2	7.9	11/16
12	SS-12M0-9-HV35	36.0	22.8	9.5	13/16
16	SS-16M0-9-HV35	38.0	24.4	12.7	15/16

Tees

Unions

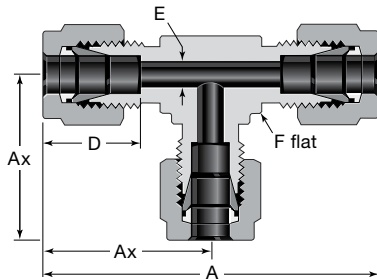

Tube ports are identical.

Tube OD	Ordering Number	Dimensions				
		A	Ax	D	E	F, in.
Dimensions, in.						
1/4	SS-400-3-HV35	2.12	1.06	0.60	0.19	1/2
3/8	SS-600-3-HV35	2.40	1.20	0.66	0.28	5/8
1/2	SS-810-3-HV35	2.84	1.42	0.90	0.41	13/16
5/8	SS-1010-3-HV35	3.06	1.53	0.96	0.50	1
Dimensions, mm						
6	SS-6M0-3-HV35	53.9	27.0	15.3	4.8	1/2
8	SS-8M0-3-HV35	59.7	29.9	16.2	6.4	5/8
10	SS-10M0-3-HV35	63.0	31.5	17.2	7.9	11/16
12	SS-12M0-3-HV35	72.0	36.0	22.8	9.5	13/16
16	SS-16M0-3-HV35	77.6	38.8	24.4	12.7	1

Cross

Union

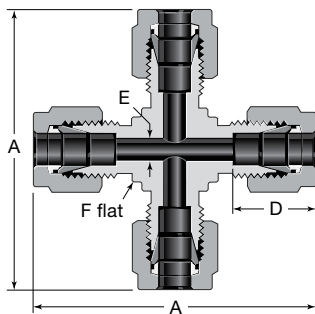

Tube ports are identical.

Tube OD	Ordering Number	Dimensions			
		A	D	E	F, in.
Dimensions, in.					
1/4	SS-400-4-HV35	2.12	0.60	0.19	1/2
3/8	SS-600-4-HV35	2.40	0.66	0.28	5/8
1/2	SS-810-4-HV35	2.84	0.90	0.41	13/16
Dimensions, mm					
6	SS-6M0-4-HV35	53.9	15.3	4.8	1/2
8	SS-8M0-4-HV35	59.7	16.2	6.4	5/8
10	SS-10M0-4-HV35	67.0	17.2	7.9	13/16
12	SS-12M0-4-HV35	72.0	22.8	9.5	13/16
16	SS-16M0-4-HV35	74.0	24.4	12.7	15/16

Additional sizes are available. Contact your local authorized Swagelok sales and service center for details.

Tube Adapters

Male

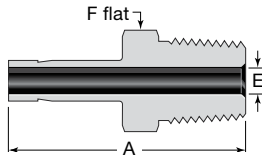

NPT

Tube OD	NPT Size in.	Ordering Number	Dimensions		
			A	E ^①	F
Dimensions, in.					
1/4	1/4	SS-4-TA-1-4-HV35	1.46	0.17	9/16
3/8	1/4	SS-6-TA-1-4-HV35	1.53	0.27	9/16
1/2	1/4	SS-8-TA-1-4-HV35	1.75	0.28	9/16
Dimensions, mm					
6	1/4	SS-6-MTA-1-4-HV35	38.1	4.1	14
8	1/4	SS-8-MTA-1-4-HV35	39.1	5.6	14
10	1/4	SS-10-MTA-1-4-HV35	39.9	7.1	14
12	1/4	SS-12-MTA-1-4-HV35	46.5	7.1	16

① The E dimension is the minimum nominal opening. These fittings may have a larger opening at the pipe/straight thread end.

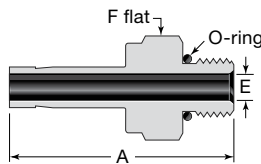

Adapts to SAE J1926/1 and ISO 11926-1 straight thread boss.

SAE/MS Straight Thread (ST) and (STH - Heavy Wall)

Tube OD	SAE/MS Thread Size	Ordering Number	Dimensions		
			A	E ^①	F
Dimensions, in.					
1/4	7/16-20	SS-4-TA-1-4ST-HV35	1.39	0.17	9/16
3/8	7/16-20	SS-6-TA-1-4ST-HV35	1.46	0.20	9/16
	9/16-18	SS-6-TA-1-6ST-HV35	1.52	0.27	11/16
	3/4-16	SS-6-TA-1-8STH-HV35	1.69	0.27	7/8
1/2	9/16-18	SS-8-TA-1-6ST-HV35	1.74	0.28	11/16
	3/4-16	SS-8-TA-1-8STH-HV35	1.95	0.37	7/8
Dimensions, mm					
6	7/16-20	SS-6-MTA-1-4ST-HV35	32.0	4.1	14
8	7/16-20	SS-8-MTA-1-4ST-HV35	32.8	5.2	14
	9/16-18	SS-8-MTA-1-6ST-HV35	34.5		18
10	9/16-18	SS-10-MTA-1-6ST-HV35	35.1	7.1	18
	3/4-16	SS-10-MTA-1-8STH-HV35	39.9		22
12	9/16-18	SS-12-MTA-1-6ST-HV35	41.7	7.1	18
	3/4-16	SS-12-MTA-1-8STH-HV35	46.5		8.8

O-ring material is 75 durometer fluorocarbon FKM.

① The E dimension is the minimum nominal opening. These fittings may have a larger opening at the pipe/straight thread end.

Female

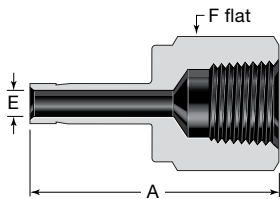

NPT

Tube OD	NPT Size in.	Ordering Number	Dimensions		
			A	E	F
Dimensions, in.					
1/4	1/4	SS-4-TA-7-4-HV35	1.46	0.17	3/4
3/8	1/4	SS-6-TA-7-4-HV35	1.50	0.27	3/4
1/2	1/4	SS-8-TA-7-4-HV35	1.71	0.37	3/4
Dimensions, mm					
6	1/4	SS-6-MTA-7-4-HV35	37.1	4.1	19
8	1/4	SS-8-MTA-7-4-HV35	37.6	5.6	19
10	1/4	SS-10-MTA-7-4-HV35	38.1	7.1	19
12	1/4	SS-12-MTA-7-4-HV35	43.7	8.8	19

Refer to [Gaugeable Tube Fittings and Adapter Fittings catalog, MS-01-140](#), for additional information.

Additional sizes are available. Contact your local authorized Swagelok sales and service center for details.

Pipe Fittings

Adapters

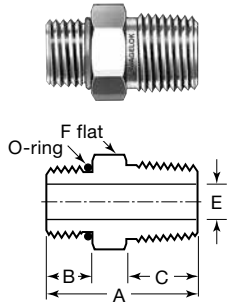

Male SAE/MS Straight Thread to Male NPT

SAE/MS Thread Size in.	NPT Size in.	Ordering Number	Dimensions in. (mm)					Uniform O-Ring ^① Size
			A	B	C	E	F	
7/16-20	1/4	SS-4-SAE-1-4-HV35	1.20 (30.5)	0.36 (9.1)	0.56 (14.2)	0.20 (5.1)	9/16	-904

① O-ring material is 75 durometer fluorocarbon FKM.

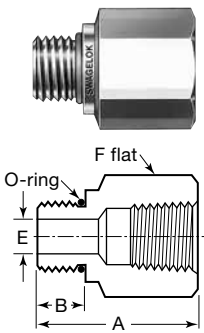

Male SAE/MS Straight Thread to Female NPT

SAE/MS Thread Size in.	NPT Size in.	Ordering Number	Dimensions in. (mm)				Uniform O-Ring ^① Size
			A	B	E	F	
7/16-20	1/4	SS-4-SAE-7-4-HV35	1.32 (33.5)	0.36 (9.1)	0.20 (5.1)	3/4	-904

① O-ring material is 75 durometer fluorocarbon FKM.

Reducers

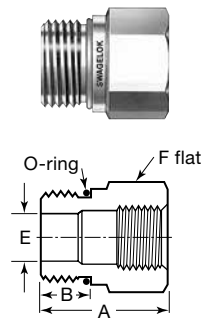

Male to Female SAE/MS Straight Thread (ST)

Male Thread Size in.	Female Thread Size in.	Ordering Number	Dimensions in. (mm)				Uniform O-Ring ^① Size
			A	B	E	F	
9/16-18	7/16-20	SS-6-RBST-4-HV35	1.12 (28.4)	0.39 (9.9)	0.28 (7.1)	13/16	-906
3/4-16	7/16-20	SS-8-RBSTH-4-HV35	1.10 (28.0)	0.55 (14.0)	0.39 (9.9)	7/8	-908
	9/16-18	SS-8-RBSTH-6-HV35	1.31 (33.3)	0.55 (14.0)	0.42 (10.7)	1	-908

① O-ring material is 75 durometer fluorocarbon FKM.

Pipe Plugs

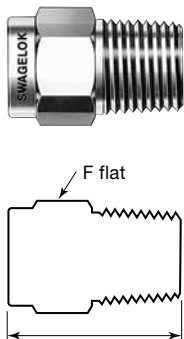

Male NPT

NPT Size in.	Ordering Number	Dimensions in. (mm)	
		A	F
1/4	SS-4-P-HV35	0.96 (24.4)	9/16

Additional sizes are available. Contact your local authorized Swagelok sales and service center for details.

Pipe Fittings

Hollow Hex Plugs

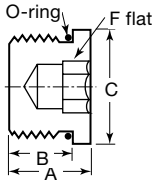

Male SAE/MS Straight Thread (ST) and (STH - Heavy Wall)

SAE/MS Thread Size in.	Ordering Number	Dimensions in. (mm)				Uniform O-Ring ^① Size
		A	B	C	F	
3/8-24	SS-3-HPST-HV35	0.39 (9.9)	0.30 (7.6)	0.49 (12.5)	1/8	-903
7/16-20	SS-4-HPST-HV35	0.45 (11.4)	0.36 (9.1)	0.56 (14.2)	3/16	-904
9/16-18	SS-6-HPST-HV35	0.48 (12.2)	0.39 (9.9)	0.69 (17.5)	1/4	-906
3/4-16	SS-8-HPSTH-HV35	0.67 (17.0)	0.55 (14.0)	0.87 (22.1)	5/16	-908

① O-ring material is 75 durometer fluorocarbon FKM.

Hex Head Plugs

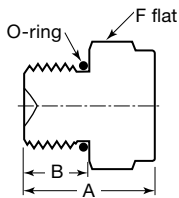

Male SAE/MS Straight Thread (ST) and (STH - Heavy Wall)

SAE/MS Thread Size in.	Basic Ordering Number	Dimensions in. (mm)			Uniform O-Ring ^① Size
		A	B	F	
3/8-24	SS-3-PST-HV35	0.68 (17.3)	0.30 (7.6)	1/2	-903
7/16-20	SS-4-PST-HV35	0.76 (19.3)	0.36 (9.1)	9/16	-904
9/16-18	SS-6-PST-HV35	0.82 (20.8)	0.39 (9.9)	11/16	-906
3/4-16	SS-8-PSTH-HV35	0.99 (25.1)	0.55 (14.0)	7/8	-908

① O-ring material is 75 durometer fluorocarbon FKM.

Pipe Caps

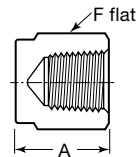

Female NPT

NPT Size in.	Basic Ordering Number	Dimensions in. (mm)	
		A	F
1/4	SS-4-CP-HV35	0.91 (23.1)	3/4

Refer to [Pipe Fittings catalog, MS-01-147](#), for additional information.

Additional sizes are available. Contact your local authorized Swagelok sales and service center for details.

Ordering Numbers and Dimensions for Valves With EC-79 Certification for Systems Above 30 bar (435 psig) and Up to 350 bar (5 076 psig), Temperature -40 to 120°C (-40 to 248°F) – H35 Pressure Class

Alternative Fuel Service Ball Valve (AFS Series)

Ordering Information and Dimensions

Select an ordering number.

Dimensions, in inches (millimeters), are for reference only and are subject to change.

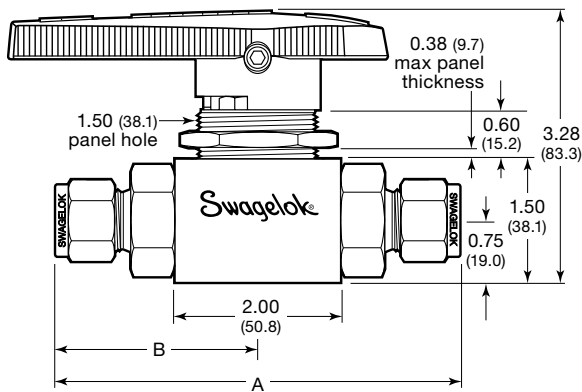
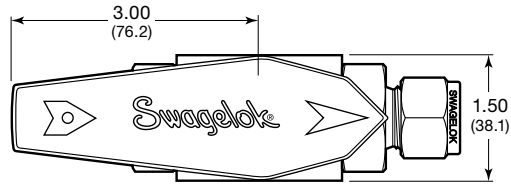

End Connections ^①		Ordering Number	C _v	Orifice in. (mm)	Dimensions in. (mm)	
Type	Size				A	B
Fractional Swagelok tube fitting	3/8 in.	SS-AFSS6-HV35	4.0	0.281 (7.1)	4.57 (116)	2.29 (58.2)
	1/2 in.	SS-AFSS8-HV35	7.2	0.406 (10.3)	4.80 (122)	2.40 (61.0)
Metric Swagelok tube fitting	12 mm	SS-AFSS12MM-HV35	5.2	0.406 (10.3)	4.80 (122)	2.20 (55.9)
	16 mm	SS-AFSS16MM-HV35	12.4	0.472 (12.0)	4.80 (122)	2.40 (61.0)
Female NPT	3/8 in.	SS-AFSF6-HV35	11.0	0.472 (12.0)	4.00 (102)	2.00 (50.8)
	1/2 in.	SS-AFSF8-HV35	13.8		4.00 (102)	2.00 (50.8)
SAE	1/2 in.	SS-AFSMS8-HV35	13.8	0.472 (12.0)	4.00 (102)	2.00 (50.8)

Dimensions shown with Swagelok tube fitting nuts finger-tight.

① Valves can be ordered with two different end connections. Contact your authorized Swagelok sales and service representative.

Marking

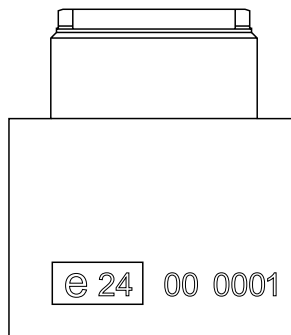
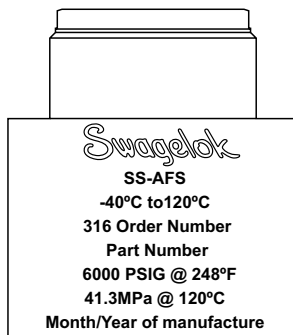

Refer to *Alternative Fuel Service AFS Ball Valve* catalog, MS-02-303, for additional information.

Additional configurations may be available. Contact your local authorized Swagelok sales and service center for details.

Check Valves

CH Series

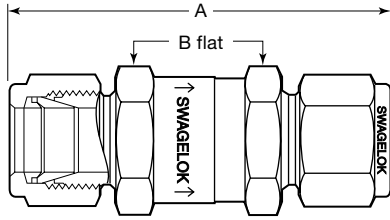

End Connections		Basic Ordering Number	Series	Dimensions in. (mm)	
Type	Size			A	B
Fractional Swagelok tube fitting	1/4 in.	SS-CHS4-XX-YY-HV35	CH4	2.43 (61.7)	11/16
	3/8 in.	SS-CHS6-XX-YY-HV35	CH8	2.75 (69.9)	1
	1/2 in.	SS-CHS8-XX-YY-HV35		2.96 (75.2)	
Metric Swagelok tube fitting	6 mm	SS-CHS6MM-XX-YY-HV35	CH4	2.43 (61.7)	11/16
	8 mm	SS-CHS8MM-XX-YY-HV35	CH8	2.70 (68.6)	1
	10 mm	SS-CHS10MM-XX-YY-HV35		2.80 (71.1)	
	12 mm	SS-CHS12MM-XX-YY-HV35		2.96 (75.2)	
Female NPT	1/4 in.	SS-CHF4-XX-YY-HV35	CH4	2.13 (54.1)	11/16
Male NPT	1/4 in.	SS-CHM4-XX-YY-HV35	CH4	2.17 (55.1)	11/16
	3/8 in.	SS-CHM6-XX-YY-HV35	CH8	2.36 (59.9)	1
	1/2 in.	SS-CHM8-XX-YY-HV35		2.73 (69.3)	

⚠ Check valves are designed for directional flow control only. Swagelok check valves should never be used as code safety relief devices.

Replace XX in the basic ordering number with the seal material designator below.
 Replace YY in the basic ordering number with the cracking pressure designator below.

Seal Materials

Seal Material	Designator
Ethylene propylene	-EP
Neoprene	-NE

To order, insert the seal material designator into the valve ordering number.

Example: SS-CHS4-**EP**-1/3-HV35

Cracking Pressure

Cracking Pressure psi (bar)	Designator
1/3 (0.03)	1/3
1 (0.07)	1
5 (0.35)	5
10 (0.69)	10
25 (1.8)	25

To order, add a cracking pressure designator to the basic ordering number.

Example: SS-CHS4-EP-**1/3**-HV35

Marking

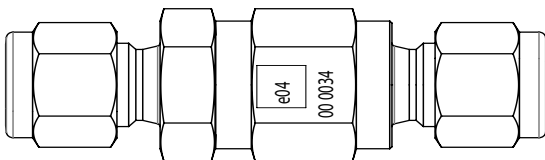

Refer to [Check Valves catalog, MS-01-176](#), for additional information.

Additional configurations may be available. Contact your local authorized Swagelok sales and service center for details.

Industrial Excess Flow Valves

XS Series

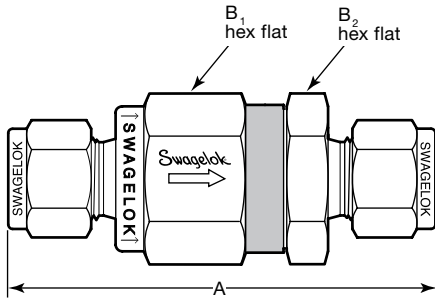

End Connections		Pressure Rating at 100°F (37°C) psig (bar)	Ordering Number	Series	Dimensions, in. (mm)		
Inlet/Outlet	Size				A	B ₁	B ₂
Fractional Swagelok tube fitting	1/4 in.	6000 (413)	SS-XSS4-HV35	XS4	2.43 (61.7)	11/16	
Metric Swagelok tube fitting	6 mm	6000 (413)	SS-XSS6MM-HV35	XS4	2.43 (61.7)	11/16	
Female NPT	1/4 in.	6000 (413)	SS-XSF4-HV35	XS4	2.12 (53.8)	11/16	

Dimensions shown with Swagelok nuts finger-tight.

HV35 assemblies only available with ethylene propylene seals.

Marking

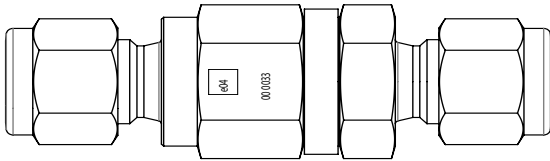

Refer to *Industrial Excess Flow Valves* catalog, MS-01-110, for additional information.

Additional configurations may be available. Contact your local authorized Swagelok sales and service center for details.

Filters

TF Series

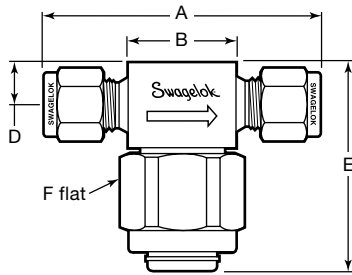

End Connections		Basic Ordering Number	Filter Series	Dimensions, in. (mm)						
Type	Size			Orifice	A	B	C	D	E	F
Swagelok tube fitting	1/4 in.	SS-4TF-XX-HV35	4TF	0.174 (4.41)	2.47 (62.7)	1.06 (26.9)	1.00 (25.4)	0.38 (9.7)	1.87 (47.5)	1 (25.4)
	3/8 in.	SS-6TF-XX-HV35	6TF	0.213 (5.41)	2.84 (72.1)	1.32 (33.5)	1.13 (28.7)	0.46 (11.7)	2.20 (55.9)	1 1/8 (28.6)
	1/2 in.	SS-8TF-XX-HV35	8TF	0.250 (6.35)	3.04 (77.2)	1.31 (33.3)				
	6 mm	SS-6TF-MM-XX-HV35	4TF	0.172 (4.36)	2.46 (62.5)	1.06 (26.9)	1.00 (25.4)	0.38 (9.7)	1.87 (47.5)	1 (25.4)
	8 mm	SS-8TF-MM-XX-HV35	6TF	0.213 (5.41)	2.84 (72.1)	1.38 (35.1)	1.13 (28.7)	0.46 (11.7)	2.20 (55.9)	1 1/8 (28.6)
	10 mm	SS-10TF-MM-XX-HV35	8TF	0.250 (6.35)	2.86 (72.6)	1.32 (33.5)				
	12 mm	SS-12TF-MM-XX-HV35	8TF		3.04 (77.2)	1.31 (33.3)				
Female NPT	1/8 in.	SS-2TF4-XX-HV35	2TF	0.174 (4.41)	2.00 (50.8)	1.00 (25.4)	1.00 (25.4)	0.38 (9.7)	1.87 (47.5)	1 (25.4)
Male NPT	1/4 in.	SS-4TF2-XX-HV35	4TF	0.174 (4.41)	2.13 (54.1)	1.00 (25.4)	1.00 (25.4)	0.38 (9.7)	1.87 (47.5)	1 (25.4)

Dimensions shown with Swagelok nuts finger-tight.

Replace XX in the basic ordering number with the element designator below.

Element

Nominal Pore Size µm	Pore Size Range µm	Element Type	Element Designator
0.5	0.5 to 2	Sintered	05
2	1 to 4		2
7	5 to 10		7
15	11 to 25		15

To order, add a element designator to the basic ordering number.

Example: SS-2TF-**05**-HV35

Marking

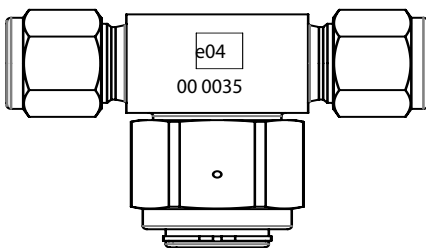

Refer to [Filters catalog, MS-01-92](#), for additional information.

Additional configurations may be available. Contact your local authorized Swagelok sales and service center for details.

Filters

FW Series

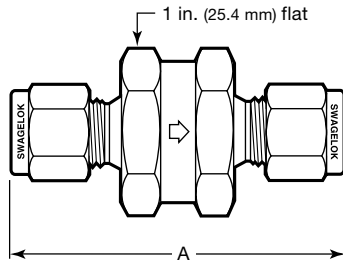

End Connections		Element Nominal Pore Size μm	Basic Ordering Number	Dimensions, in. (mm)	
Inlet/Outlet	Size			Orifice	A
Swagelok tube fittings	1/4 in.	0.5	SS-4FWS-XX-HV35	0.187 (4.75)	2.09 (53.1)
	1/4 in.	2, 7, 15	SS-4FW-XX-HV35		2.15 (54.6)
	6 mm	0.5	SS-6FWS-MM-XX-HV35		2.13 (54.1)
	6 mm	2, 7, 15	SS-6FW-MM-XX-HV35		2.15 (54.6)
Female NPT	1/4 in.	2, 7, 15	SS-4FW4-XX-HV35	0.453 (11.5)	1.57 (39.9)
Male NPT	1/4 in.		SS-4FW2-XX-HV35	0.281 (7.14)	1.89 (48.0)
Male/female NPT	1/4 in.		SS-4FW5-XX-HV35	0.281 (7.14)	1.72 (43.7)

Dimensions shown with Swagelok nuts finger-tight.

Replace XX in the basic ordering number with the element designator below.

Element

Nominal Pore Size μm	Pore Size Range μm	Element Type	Element Designator
0.5	0.5 to 2	Sintered	05
2	1 to 4		2
7	5 to 10		7
15	11 to 25		15

To order, add a element designator to the basic ordering number.

Example: SS-4FWS-05-HV35

Marking

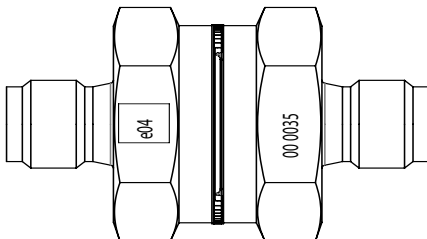

Refer to [Filters catalog, MS-01-92](#), for additional information.

Additional configurations may be available. Contact your local authorized Swagelok sales and service center for details.

Fittings With EC-79 Certification for Systems Above 30 bar (435 psig) and Up to 700 bar (10 159 psig), Temperature -40 to 85°C (-40 to 185°F) – H70 Pressure Class

Product	Product Type	Description	Available Sizes ^①	
Medium-Pressure Tube Fitting (FK Series)	Straight	Union - FK series fitting to FK series fitting Port connector Cap Plug	FK series fitting: 1/4, 3/8, 1/2 in. 6, 10, 12 mm Ordering Information: pages 27 to 30	
		Male connector - FK series fitting to 1/4 in. male NPT	FK series fitting: 1/4, 3/8, 1/2 in. 6, 10, 12 mm Ordering Information: page 27	
		Male connector - FK series fitting to SAE/MS straight thread (STH fitting) ^②	FK series fitting: 1/4, 3/8, 1/2 in. 6, 10, 12 mm SAE/MS straight thread Male: STH: 7/16-20, 9/16-18 Ordering Information: page 28	
		Female connector - FK series fitting to 1/4 in. female NPT	FK series fitting: 1/4, 3/8, 1/2 in. Ordering Information: page 28	
		Reducing Union - FK series fitting to FK series fitting	3/8, 1/2 in. 10, 12 mm Ordering Information: page 28	
		Reducer - FK series fitting to FK series fitting	1/4, 3/8, 1/2 in. Ordering Information: page 28	
		Medium-Pressure Cone and Thread Adapter Medium-Pressure Male and Female, One-Piece	FK series fitting: 1/4 in. and 6 mm Ordering Information: page 29	
	Elbow	Union - FK series fitting to FK series fitting	1/4, 3/8, 1/2 in. 6, 10, 12 mm Ordering Information: page 30	
		Reducing Union - FK series fitting to FK series fitting	1/4, 3/8 in. 6, 10 mm Ordering Information: page 31	
	Tee	Union - all FK series fitting ends	1/4, 3/8, 1/2 in. 6, 10, 12 mm Ordering Information: page 31	
	Cross	Union - all FK series fitting ends	1/4, 3/8, 1/2 in. 6, 10, 12 mm Ordering Information: page 31	
	Tube Adapter (FK Series)	Male	1/4 in. Male NPT	1/4, 3/8, 1/2 in. Ordering Information: page 31

① Additional sizes are available. Contact your local authorized Swagelok sales and service center for details.

② O-ring is 90 durometer EPDM.

Fittings With EC-79 Certification for Systems Above 30 bar (435 psig) and Up to 700 bar (10 159 psig), Temperature -40 to 85°C (-40 to 185°F) – H70 Pressure Class

Product	Product Type	Description	Available Sizes ^①
Tube fitting	AbT	AbT Nut and Ferrule Set	1/4 in. and 6 mm Ordering Information: page 26
	Straight	Union - Swagelok tube fitting to Swagelok tube fitting Bulkhead Union Port connector Cap Plug	Tube fitting sizes: 1/4 in. and 6 mm Ordering Information: pages 32 and 33
		Male connector - Swagelok tube fitting to 1/4 in. male NPT	Tube fitting sizes: 1/4 in. and 6 mm Ordering Information: page 32
		Male connector - Swagelok tube fitting to SAE/MS straight thread (STH) fitting ^②	Tube fitting sizes: 1/4 in. and 6 mm SAE/MS straight thread Male: STH: 7/16-20, 9/16-18 Ordering Information: page 32
		Female connector - Swagelok tube fitting to 1/4 in. female NPT	Tube fitting sizes: 1/4 in. and 6 mm Ordering Information: page 33
		Reducer - Swagelok tube fitting to tube adapter	1/4 in. and 6 mm Ordering Information: page 33
	Elbow	Union - Swagelok tube fitting to Swagelok tube fitting	1/4 in. and 6 mm Ordering Information: page 33
	Tee	Union - all Swagelok tube fitting ends	1/4 in. and 6 mm Ordering Information: page 34
	Cross	Union - all Swagelok tube fitting ends	1/4 in. and 6 mm Ordering Information: page 34
	Tube adapter	Male	1/4 in. NPT
SAE/MS straight thread (STH) ^②			SAE/MS straight thread STH: 7/16-20 Ordering Information: page 34
Female		1/4 in. NPT	Tube adapter sizes: 1/4 in. 6 mm Ordering Information: page 35
Pipe fittings	Hex head plug	Male SAE/MS straight thread (ST and STH) ^②	SAE/MS straight thread ST: 7/16-20, 9/16-18 Ordering Information: page 35
	Pipe cap	Female NPT	1/4, 3/8, 1/2 in. Ordering Information: page 35

① Additional sizes are available. Contact your local authorized Swagelok sales and service center for details.

② O-ring is 90 durometer EPDM.

Ordering Numbers and Dimensions for Fittings With EC-79 Certification for Systems Above 30 bar (435 psig) and Up to 700 bar (10 159 psig), Temperature -40 to 85°C (-40 to 185°F) – H70 Pressure Class

Assembly-by-Torque (AbT) Fittings

AbT Nut and Ferrule Set (sold separately for easy installation)

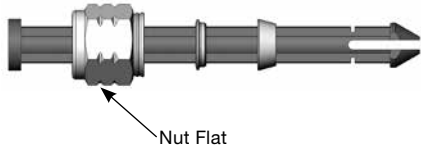

Tube OD	Ordering Number ^①	Sets per Blister Pack	Dimension
			Nut Flat
Fractional, in.			
1/4	SS-4ABT-NFSET-HV70	50	9/16 in.
Metric, mm			
6	SS-6MABT-NFSET-HV70	50	14 mm

^① Order in blister packs.

Marking

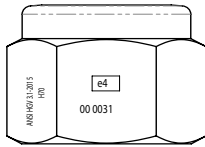

AbT Body Only Ordering Information:

- AbT union body see page 32 for base ordering number and dimensions, add **BO** to base ordering number.
Example: SS-400-6**BO**-HV70
- AbT male connector body SAE/MS straight thread heavy wall (STH) see page 32 for base ordering number and dimensions, add **BO** to base ordering number.
Example: SS-400-1-4**STHBO**-HV70
- AbT elbow union body see page 33 for base ordering number and dimensions, add **BO** to base ordering number.
Example: SS-400-9**BO**-HV70
- AbT tee union body see page 34 for base ordering number and dimensions, add **BO** to base ordering number.
Example: SS-400-3**BO**-HV70
- AbT cross union see page 34 for base ordering number and dimensions, add **BO** to base ordering number.
Example: SS-400-4**BO**-HV70

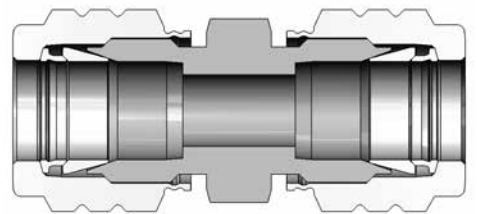

FK Series Straight Fittings

Marking

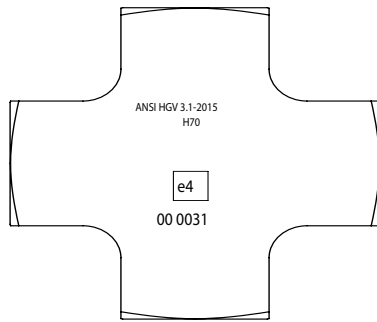

Unions

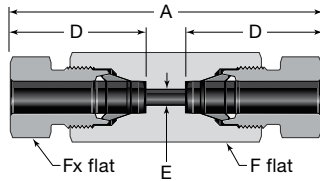

Union

Tube OD	Ordering Number	Dimensions				
		A	D	E	F	Fx
Dimensions, in.						
1/4	SS-4FK0-6-HV70	2.25	1.08	0.13	5/8	9/16
3/8	SS-6FK0-6-HV70	2.81	1.34	0.21	3/4	11/16
1/2	SS-8FK0-6-HV70	3.36	1.59	0.38	1	7/8
Dimensions, mm						
6	SS-6MFK0-6-HV70	57.2	27.4	3.2	16	15
10	SS-10MFK0-6-HV70	85.3	40.4	5.6	24	22
12	SS-12MFK0-6-HV70	85.3	40.4	6.4	27	22

Male Connectors

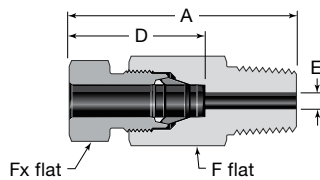

NPT

Tube OD	NPT Size in.	Ordering Number	Dimensions				
			A	D	E	F	Fx
Dimensions, in.							
1/4	1/4	SS-4FK0-1-4-HV70	1.74	1.08	0.13	5/8	9/16
3/8	1/4	SS-6FK0-1-4-HV70	2.03	1.34	0.21	3/4	11/16
1/2	1/4	SS-8FK0-1-4-HV70	2.33	1.59	0.25	1	7/8
Dimensions, mm							
6	1/4	SS-6MFK0-1-4-HV70	44.1	27.4	3.2	16	15
10	1/4	SS-10MFK0-1-4-HV70	59.1	40.4	5.6	24	22
12	1/4	SS-12MFK0-1-4-HV70	59.1	40.4	6.4	27	22

Additional sizes are available. Contact your local authorized Swagelok sales and service center for details.

Straight Fittings

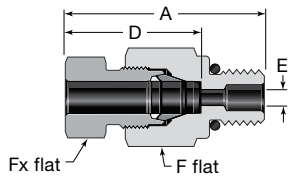

Heavy-Duty Male SAE/MS (STH)

Tube OD	SAE/MS ^① Thread Size	Ordering Number	Dimensions				
			A	D	E ^②	F	Fx
Dimensions, in.							
1/4	7/16-20	SS-4FK0-1-4STH-HV70	1.61	1.08	0.13	5/8	9/16
	9/16-18	SS-4FK0-1-6STH-HV70	1.65	1.08	0.13	3/4	9/16
3/8	7/16-20	SS-6FK0-1-4STH-HV70	1.91	1.34	0.18	3/4	11/16
	9/16-18	SS-6FK0-1-6STH-HV70	1.95	1.34	0.23	3/4	11/16
1/2	7/16-20	SS-8FK0-1-4STH-HV70	2.29	1.59	0.18	1	7/8
	9/16-18	SS-8FK0-1-6STH-HV70	2.29	1.59	0.23	1	7/8
Dimensions, mm							
6	7/16-20	SS-6MFK0-1-4STH-HV70	40.8	27.4	3.2	16	15
	9/16-18	SS-6MFK0-1-6STH-HV70	41.8	27.4	3.2	19	15
10	7/16-20	SS-10MFK0-1-4STH-HV70	58.2	40.4	4.5	24	22
	9/16-18	SS-10MFK0-1-6STH-HV70	58.2	40.4	5.6	24	22
12	7/16-20	SS-12MFK0-1-4STH-HV70	58.2	40.4	4.5	27	22
	9/16-18	SS-12MFK0-1-6STH-HV70	58.2	40.4	5.8	27	22

① O-ring is 90 durometer EPDM.

② The E dimension is the minimum nominal opening. These fittings may have a larger opening at the pipe/straight thread end.

Female Connectors

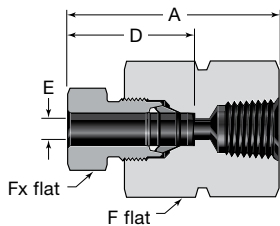

NPT

Tube OD in.	NPT Size in.	Ordering Number	Dimensions, in.				
			A	D	E	F	Fx
1/4	1/4	SS-4FK0-7-4-HV70	1.85	1.08	0.13	1	9/16
3/8	1/4	SS-6FK0-7-4-HV70	2.10	1.34	0.21	1	11/16
1/2	1/4	SS-8FK0-7-4-HV70	2.42	1.59	0.38	1	7/8

Reducers

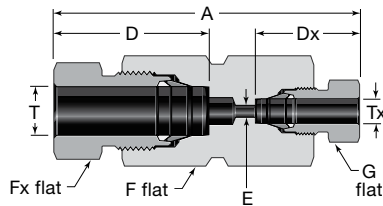

Reducing Union

Tube OD	T	Tx	Ordering Number	Dimensions						
				A	D	Dx	E	F	Fx	G
Dimensions, in.										
3/8	1/4		SS-6FK0-6-4-HV70	2.64	1.34	1.08	0.13	3/4	11/16	9/16
	1/2		SS-8FK0-6-4-HV70	2.90	1.59	1.34	0.13	1	7/8	9/16
1/2	3/8		SS-8FK0-6-6-HV70	3.19	1.59	1.34	0.21	1	7/8	11/16
	Dimensions, mm									
10	6		SS-10MFK0-6-6M-HV70	74.0	40.4	27.4	3.2	24	22	15
	6		SS-12MFK0-6-6M-HV70	74.0	40.4	27.4	3.2	27	22	15
12	6		SS-12MFK0-6-10M-HV70	86.4	40.4	40.4	5.6	27	22	22

Reducer

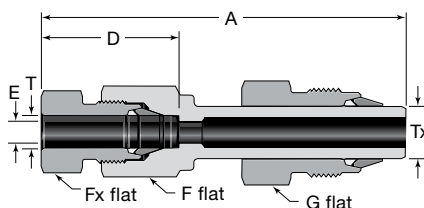

Tube OD, in.	T	Tx	Ordering Number	Dimensions, in.					
				A	D	E	F	Fx	G
1/4	3/8		SS-4FK0-R-6FK-HV70	2.97	1.08	0.13	5/8	9/16	11/16
	1/2		SS-4FK0-R-8FK-HV70	3.31	1.08	0.13	5/8	9/16	7/8
3/8	1/2		SS-6FK0-R-8FK-HV70	3.52	1.34	0.21	3/4	11/16	7/8
1/2	3/8		SS-8FK0-R-6FK-HV70	3.65	1.59	0.21	1	7/8	11/16

Reducers are furnished with nuts and preswaged ferrules.

Additional sizes are available. Contact your local authorized Swagelok sales and service center for details.

Straight Fittings

Medium-Pressure Cone and Thread Adapters

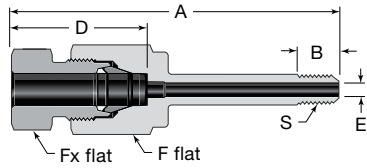

Tube Nipple

Tube OD	C&T Tube Size in.	Ordering Number	S Thread Size	Dimensions					
				A	B	D	E	F	Fx
Dimensions, in.									
1/4	1/4	SS-4FK0-1-4CW-HV70	1/4-28 LH	2.70	0.31	1.08	0.11	5/8	9/16
Dimensions, mm									
6	1/4	SS-6MFK0-1-4CW-HV70	1/4-28 LH	68.5	7.9	27.4	2.7	16	15

To protect surfaces from galling at installation, apply a system-compatible lubricant to the nose and threads of the coned end.

Standard CW end connections are not compatible with anti-vibration glands. Contact your authorized Swagelok representative for information on long CW end connections.

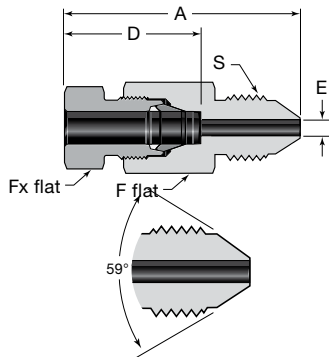

Male, One-Piece

Tube OD	C&T Tube Size in.	Ordering Number	S Thread Size	Dimensions				
				A	D	E	F	Fx
Dimensions, in.								
1/4	1/4	SS-4FK0-1-4MP-HV70	7/16-20 UN	1.94	1.08	0.11	5/8	9/16
	3/8	SS-4FK0-1-6MP-HV70	9/16-18 UN	2.17	1.08	0.13	5/8	9/16
3/8	3/8	SS-6FK0-1-6MP-HV70	9/16-18 UN	2.42	1.34	0.21	3/4	11/16
Dimensions, mm								
6	1/4	SS-6MFK0-1-4MP-HV70	7/16-20 UN	49.3	27.4	2.7	16	15
10	3/8	SS-10MFK0-1-6MP-HV70	9/16-20 UN	70.1	40.4	5.3	24	22

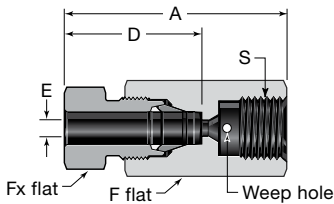

Female^①

Tube OD	C&T Tube Size in.	Ordering Number	S Thread Size	Dimensions				
				A	D	E	F	Fx
Dimensions, in.								
1/4	1/4	SS-4FK0-7-4MP-HV70	7/16-20 UN	1.89	1.08	0.11	11/16	9/16
3/8	3/8	SS-6FK0-7-6MP-HV70	9/16-18 UN	2.21	1.34	0.20	7/8	11/16
Dimensions, mm								
6	1/4	SS-6MFK0-7-4MP-HV70	7/16-20 UN	48.0	27.4	2.7	18	15
10	3/8	SS-10MFK0-7-6MP-HV70	9/16-18 UN	64.8	40.4	5.1	24	22

^① C&T collars and gland are not included.

Additional sizes are available. Contact your local authorized Swagelok sales and service center for details.

Straight Fittings

Port Connectors

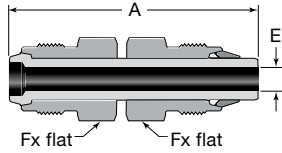

Tube OD	Ordering Number	Dimensions		
		A	E	Fx
Dimensions, in.				
1/4	SS-4FK0-PC-HV70	2.06	0.12	9/16
3/8	SS-6FK0-PC-HV70	2.54	0.21	11/16
1/2	SS-8FK0-PC-HV70	2.99	0.28	7/8
Dimensions, mm				
6	SS-6MFK0-PC-HV70	52.3	3.0	15
10	SS-10MFK0-PC-HV70	75.9	5.6	22
12	SS-12MFK0-PC-HV70	75.9	6.4	22

Port connectors are furnished with nuts and preswaged ferrules.

Caps and Plugs

Cap

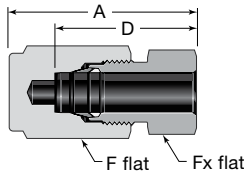

Tube OD	Ordering Number	Dimensions			
		A	D	F	Fx
Dimensions, in.					
1/4	SS-4FK0-C-HV70	1.33	1.08	5/8	9/16
3/8	SS-6FK0-C-HV70	1.74	1.34	3/4	11/16
1/2	SS-8FK0-C-HV70	2.05	1.59	1	7/8
Dimensions, mm					
6	SS-6MFK0-C-HV70	33.7	27.4	16	15
10	SS-10MFK0-C-HV70	52.0	40.4	24	22
12	SS-12MFK0-C-HV70	52.0	40.4	27	22

Plug

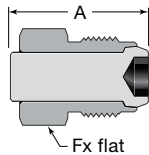

Tube OD	Ordering Number	Dimensions	
		A	Fx
Dimensions, in.			
1/4	SS-4FK0-P-HV70	1.03	9/16
3/8	SS-6FK0-P-HV70	1.26	11/16
1/2	SS-8FK0-P-HV70	1.45	7/8
Dimensions, mm			
6	SS-6MFK0-P-HV70	26.2	15
10	SS-10MFK0-P-HV70	36.7	22
12	SS-12MFK0-P-HV70	36.7	22

90° Elbows

Unions

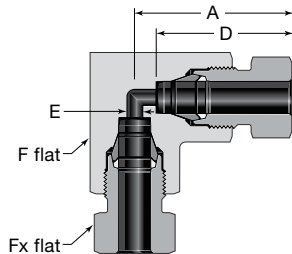

Union

Tube OD	Ordering Number	Dimensions				
		A	D	E	F, in.	Fx
Dimensions, in.						
1/4	SS-4FK0-9-HV70	1.26	1.08	0.13	5/8	9/16
3/8	SS-6FK0-9-HV70	1.58	1.34	0.21	3/4	11/16
1/2	SS-8FK0-9-HV70	1.87	1.59	0.38	1	7/8
Dimensions, mm						
6	SS-6MFK0-9-HV70	31.9	27.4	3.0	5/8	15
10	SS-10MFK0-9-HV70	47.5	40.4	5.6	1	22
12	SS-12MFK0-9-HV70	47.5	40.4	6.4	1	22

90° Elbows

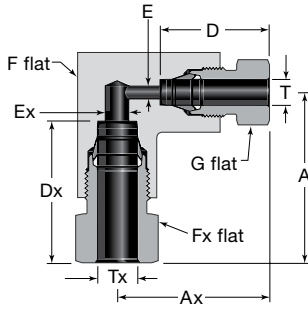

Reducing Union

Tube OD		Ordering Number	Dimensions								
T	Tx		A	Ax	D	Dx	E	Ex	F, in.	Fx	G
Dimensions, in.											
1/4	3/8	SS-6FK0-9-4-HV70	1.61	1.48	1.08	1.34	0.13	0.21	3/4	11/16	9/16
	1/2	SS-8FK0-9-4-HV70	1.91	1.69	1.08	1.59	0.13	0.38	1	7/8	9/16
3/8	1/2	SS-8FK0-9-6-HV70	1.91	1.82	1.34	1.59	0.21	0.38	1	7/8	11/16
Dimensions, mm											
6	10	SS-10MFK0-9-6M-HV70	48.5	42.8	27.4	40.4	3.2	5.6	1	22	15
	12	SS-12MFK0-9-6M-HV70	48.5	42.8	27.4	40.4	3.2	6.4	1	22	22
10	12	SS-12MFK0-9-10M-HV70	48.5	48.5	40.4	40.4	5.6	6.4	1	22	22

Tees

Unions

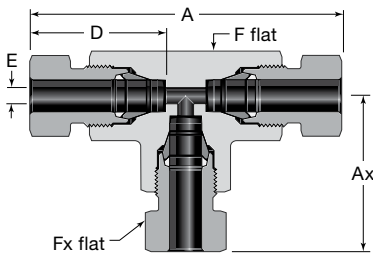

Tube OD		Ordering Number	Dimensions					
			A	Ax	D	E	F, in.	Fx
Dimensions, in.								
1/4		SS-4FK0-3-HV70	2.51	1.26	1.08	0.13	5/8	9/16
3/8		SS-6FK0-3-HV70	3.17	1.58	1.34	0.21	3/4	11/16
1/2		SS-8FK0-3-HV70	3.74	1.87	1.59	0.38	1	7/8
Dimensions, mm								
6		SS-6MFK0-3-HV70	63.8	31.9	27.4	3.2	5/8	15
10		SS-10MFK0-3-HV70	94.9	47.5	40.4	5.6	1	22
12		SS-12MFK0-3-HV70	94.9	47.5	40.4	6.4	1	22

Crosses

Unions

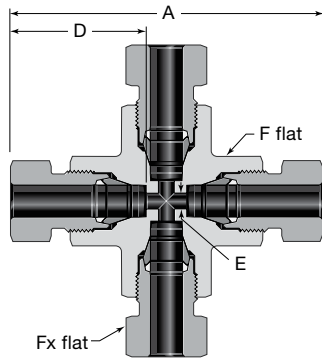

Tube OD		Ordering Number	Dimensions				
			A	D	E	F, in.	Fx
Dimensions, in.							
1/4		SS-4FK0-4-HV70	2.51	1.08	0.13	5/8	9/16
3/8		SS-6FK0-4-HV70	3.17	1.34	0.21	3/4	11/16
1/2		SS-8FK0-4-HV70	3.74	1.59	0.38	1	7/8
Dimensions, mm							
6		SS-6MFK0-4-HV70	63.8	27.4	3.0	5/8	15
10		SS-10MFK0-4-HV70	94.9	40.5	5.6	1	22
12		SS-12MFK0-4-HV70	94.9	40.5	6.4	1	22

Tube Adapters

Male NPT

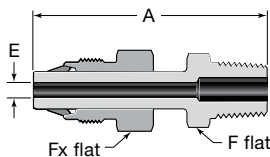

Tube OD in.	NPT Size in.	Ordering Number	Dimensions, in.			
			A	E	F	Fx
1/4	1/4	SS-4FK-TA-1-4-HV70	2.18	0.12	9/16	9/16
3/8	1/4	SS-6FK-TA-1-4-HV70	2.53	0.21	9/16	11/16
1/2	1/4	SS-8FK-TA-1-4-HV70	2.87	0.25	9/16	7/8

Tube adapters are furnished with nuts and preswaged ferrules.

Additional sizes are available. Contact your local authorized Swagelok sales and service center for details.

Ordering Numbers and Dimensions for EC-79 H70 Class (700 bar (10 159 psig)) Certified Products

Straight Tube Fittings

Markings

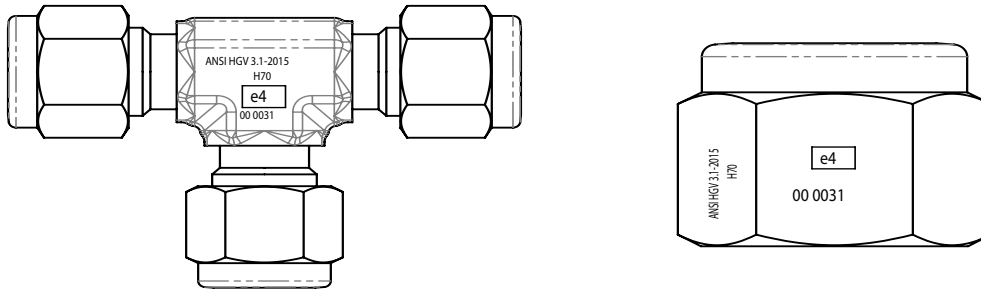

Unions

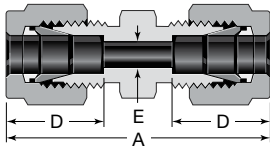

Tube OD	Ordering Number	Dimensions		
		A	D	E
Dimensions, in.				
1/4	SS-400-6-HV70	1.61	0.60	0.19
Dimensions, mm				
6	SS-6M0-6-HV70	41.0	15.3	4.8

Male Connectors

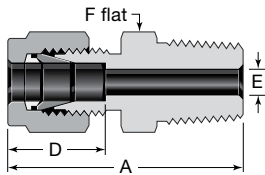

NPT

Tube OD	NPT Size	Ordering Number	Dimensions			
			A	D	E ^①	F
Dimensions, in.						
1/4	1/4	SS-400-1-4-HV70	1.49	0.60	0.19	9/16
Dimensions, mm						
6	1/4	SS-6M0-1-4-HV70	37.9	15.3	4.8	14

① The E dimension is the minimum nominal opening. These fittings may have a larger opening at the pipe/straight thread end.

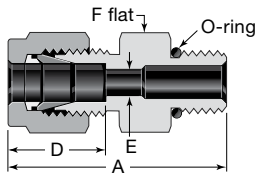

Adapts to SAE J1926/1 and ISO 11926-1 straight thread boss.

SAE/MS Straight Thread Heavy Wall (STH)

Tube OD	SAE/MS ^① Thread Size	Ordering Number	Dimensions			
			A	D	E ^②	F
Dimensions, in.						
1/4	7/16-20	SS-400-1-4STH-HV70	1.39	0.60	0.18	9/16
	9/16-18	SS-400-1-6STH-HV70	1.48			11/16
Dimensions, mm						
6	7/16-20	SS-6M0-1-4STH-HV70	35.3	15.3	4.3	14
	9/16-18	SS-6M0-1-6STH-HV70	37.1			18

① O-ring is 90 durometer EPDM.

② The E dimension is the minimum nominal opening. These fittings may have a larger opening at the pipe/straight thread end.

Additional sizes are available. Contact your local authorized Swagelok sales and service center for details.

Straight Tube Fittings

Female Connectors

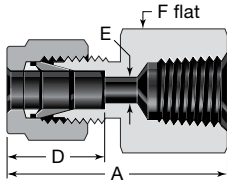

NPT

Tube OD	NPT Size	Ordering Number	Dimensions			
			A	D	E	F
Dimensions, in.						
1/4	1/4	SS-400-7-4-HV70	1.41	0.60	0.19	3/4
Dimensions, mm						
6	1/4	SS-6M0-7-4-HV70	35.8	15.3	4.8	19

Reducers

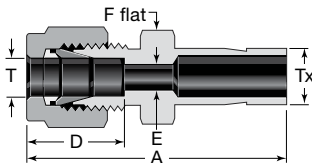

Tube OD		Ordering Number	Dimensions			
T	Tx		A	D	E	F
Dimensions, in.						
1/4	1/4	SS-400-R-4-HV70	1.54	0.60	0.17	1/2

Port Connectors

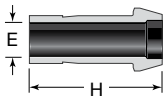

Tube OD	Ordering Number	Dimensions	
		E	H
Dimensions, in.			
1/4	SS-401-PC-HV70	0.17	0.98
Dimensions, mm			
6	SS-6M1-PC-HV70	4.1	25.0

Caps and Plugs

Cap

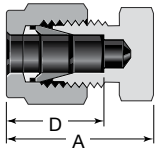

Tube OD	Ordering Number	A	D
Dimensions, in.			
1/4	SS-400-C-HV70	0.92	0.60
Dimensions, mm			
6	SS-6M0-C-HV70	23.1	15.3

Plug

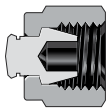

Tube OD	Ordering Number
Dimensions, in.	
1/4	SS-400-P-HV70
Dimensions, mm	
6	SS-6M0-P-HV70

90° Elbows

Unions

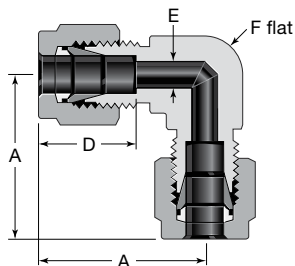

Tube ports are identical.

Tube OD	Ordering Number	Dimensions			
		A	D	E	F, in.
Dimensions, in.					
1/4	SS-400-9-HV70	1.06	0.60	0.19	1/2
Dimensions, mm					
6	SS-6M0-9-HV70	27.0	15.3	4.8	1/2

Additional sizes are available. Contact your local authorized Swagelok sales and service center for details.

Tees

Unions

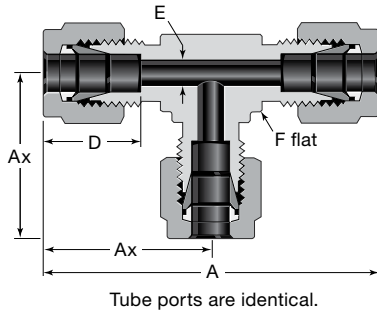

Tube OD	Ordering Number	Dimensions				
		A	Ax	D	E	F, in.
Dimensions, in.						
1/4	SS-400-3-HV70	2.12	1.06	0.60	0.19	1/2
Dimensions, mm						
6	SS-6M0-3-HV70	53.9	27.0	15.3	4.8	1/2

Cross

Union

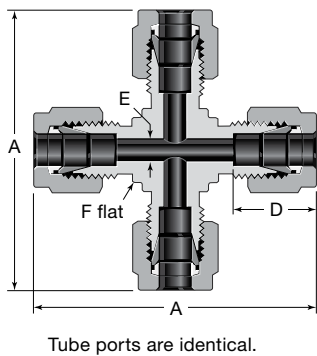

Tube OD	Ordering Number	Dimensions			
		A	D	E	F, in.
Dimensions, in.					
1/4	SS-400-4-HV70	2.12	0.60	0.19	1/2
Dimensions, mm					
6	SS-6M0-4-HV70	53.9	15.3	4.8	1/2

Tube Adapters

Male

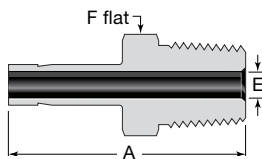

NPT

Tube OD	NPT Size in.	Ordering Number	Dimensions		
			A	E ^①	F
Dimensions, in.					
1/4	1/4	SS-4-TA-1-4-HV70	1.46	0.17	9/16
Dimensions, mm					
6	1/4	SS-6-MTA-1-4-HV70	38.1	4.1	14

① The E dimension is the minimum nominal opening. These fittings may have a larger opening at the pipe/straight thread end.

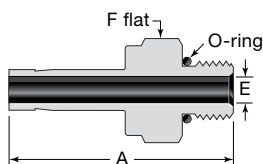

Adapts to SAE J1926/1 and ISO 11926-1 straight thread boss.

SAE/MS Straight Thread Heavy Wall (STH)

Tube OD	SAE/MS ^① Thread Size	Ordering Number	Dimensions		
			A	E ^②	F
Dimensions, in.					
1/4	7/16-20	SS-4-TA-1-4STH-HV70	1.45	0.17	9/16
Dimensions, mm					
6	7/16-20	SS-6-MTA-1-4STH-HV70	33.8	4.1	14

① O-ring is 90 durometer EPDM.

② The E dimension is the minimum nominal opening. These fittings may have a larger opening at the pipe/straight thread end.

Additional sizes are available. Contact your local authorized Swagelok sales and service center for details.

Tube Adapters

Female

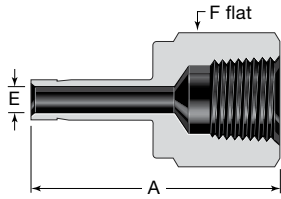

NPT

Tube OD	NPT Size in.	Ordering Number	Dimensions		
			A	E	F
Dimensions, in.					
1/4	1/4	SS-4-TA-7-4-HV70	1.46	0.17	3/4
Dimensions, mm					
6	1/4	SS-6-MTA-7-4-HV70	37.1	4.1	19

Pipe Fittings

Pipe Caps

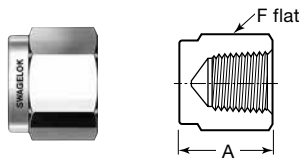

Female NPT

NPT Size in.	Basic Ordering Number	Dimensions in. (mm)	
		A	F
1/4	SS-4-CP-HV70	0.91 (23.1)	3/4
3/8	SS-6-CP-HV70	1.03 (26.2)	7/8
1/2	SS-8-CP-HV70	1.34 (34.0)	1 1/16

Hex Head Plugs

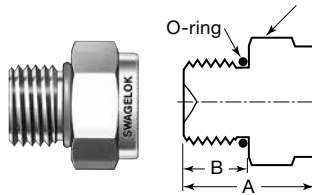

Male SAE/MS Straight Thread (ST)

SAE/MS Thread Size in.	Basic Ordering Number	Dimensions in. (mm)			Uniform O-Ring ^① Size
		A	B	F	
7/16-20	SS-4-PSTH-HV70	0.81 (20.6)	0.36 (9.1)	9/16	-904
9/16-18	SS-6-PSTH-HV70	0.88 (22.4)	0.39 (9.9)	11/16	-906

① O-ring material is 90 durometer EPDM.

Additional sizes are available. Contact your local authorized Swagelok sales and service center for details.

Replacement Parts

Swagelok Tube Fitting Nut-Ferrule Set and Ferrule Set

Use of Nuts and Ferrules

Using Swagelok nuts and ferrules on tube fittings or valves with tube end connections requires critical interaction of precision parts.

Swagelok nuts and ferrules are sold as replacement parts for use with only Swagelok bodies, fittings, valves, and hose products.

Sets are shown with arbors. One arbor holds five nut-ferrule sets.

Nut-Ferrule Set



The nut-ferrule set contains one nut, one back ferrule, and one front ferrule.

Tube OD	Basic Ordering Number	
	HV35	HV70
Dimensions, in.		
1/4	SS-400-NFSET-HV35	SS-400-NFSET-HV70
3/8	SS-600-NFSET-HV35	—
1/2	SS-810-NFSET-HV35	—
Dimensions, mm		
6	SS-6M0-NFSET-HV35	SS-6M0-NFSET-HV70
8	SS-8M0-NFSET-HV35	—
10	SS-10M0-NFSET-HV35	—
12	SS-12M0-NFSET-HV35	—

FK Series Fitting Nut and Ferrules Cartridge

Each cartridge contains a front ferrule, back ferrule, and male nut. Fractional cartridges are assembled on red arbors; metric cartridges are assembled on yellow arbors.



⚠ Do not use medium-pressure nut and ferrules with any other Swagelok tube fittings.

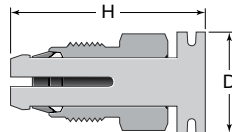

Tube OD	Ordering Number	Dimensions	
		D	H
Dimensions, in.			
1/4	SS-4FK-NFSET-HV70	0.69	1.43
3/8	SS-6FK-NFSET-HV70	0.81	1.72
1/2	SS-8FK-NFSET-HV70	1.00	1.97
Dimensions, mm			
6	SS-6MFK-NFSET-HV70	17.5	36.4
10	SS-10MFK-NFSET-HV70	25.4	49.9
12	SS-12MFK-NFSET-HV70	25.4	49.9

Safe Product Selection

When selecting a product, the total system design must be considered to ensure safe, trouble-free performance. Function, material compatibility, adequate ratings, proper installation, operation, and maintenance are the responsibilities of the system designer and user.

⚠ WARNING

Do not mix/interchange Swagelok products or components not governed by industrial design standards, including Swagelok tube fitting end connections, with those of other manufacturers.

Warranty Information

Swagelok products are backed by The Swagelok Limited Lifetime Warranty. For a copy, visit swagelok.com or contact your authorized Swagelok representative.